

HELDEN DER KINDHEIT – DAS NAHBUCH

DIE BELIEBTESTEN KULTFIGUREN ALS TASCHEN, MOTIVKISSEN, SCHLAFMASKEN UND MEHR

Alle Rechte bei ©Edition Michael Fischer GmbH, Igling

SCNITTMASTERBOGEN 1

Bei allen Schnittteilen ist die Nahtzugabe von 1 cm bereits enthalten.

BUCHHÜLLE
Ansatz Gummiband

BUCHHÜLLE

1x aus Webware



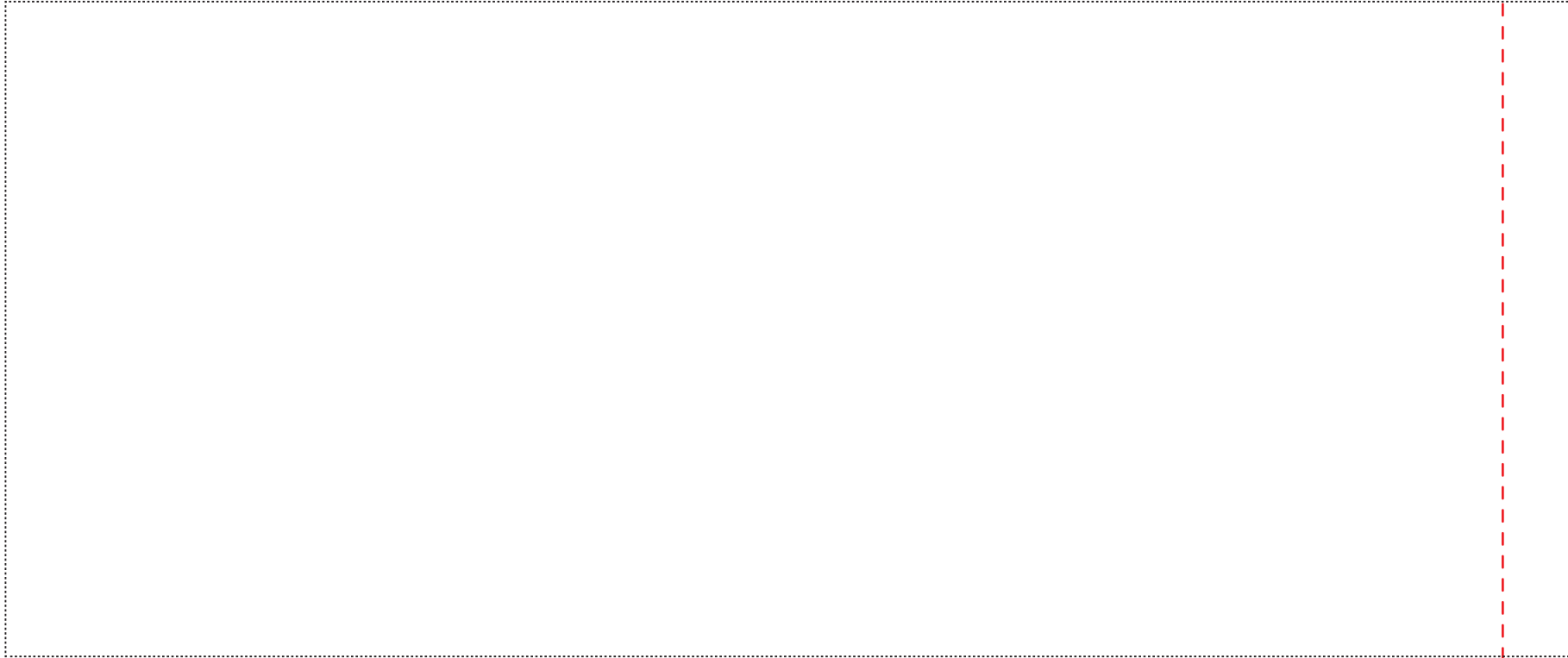

A A

B B

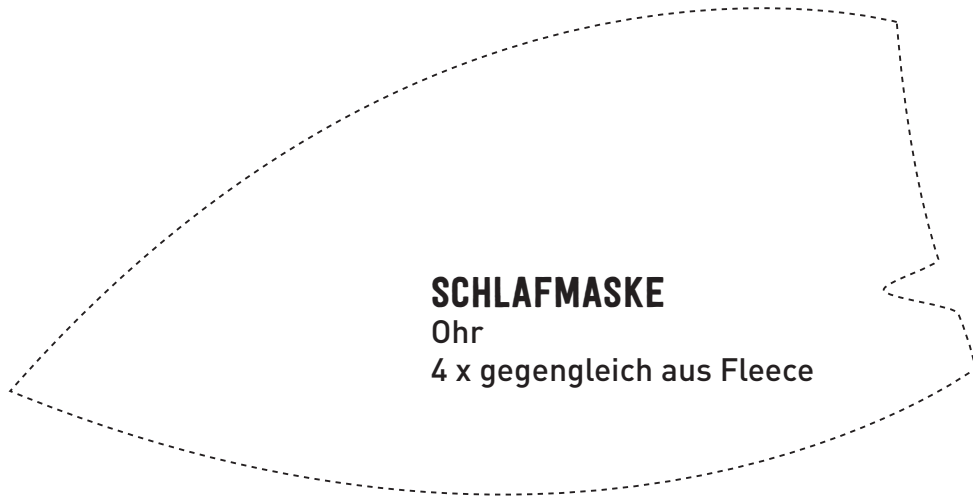

SCHLAFMASKE
Ohr
4 x gegengleich aus Fleece

2
2

SCRUNCHIE
Ring
1x aus Samt

B



SCRUNCHIE
Schleife
2x gegengleich aus Samt
1x Vliseline
zzgl. 1 cm NZ

3



3

1
1

BUCHHÜLLE
Ansatz Gummiband

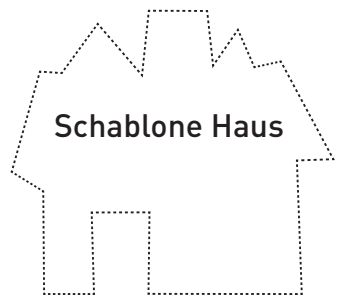

C C

4
4

2

2

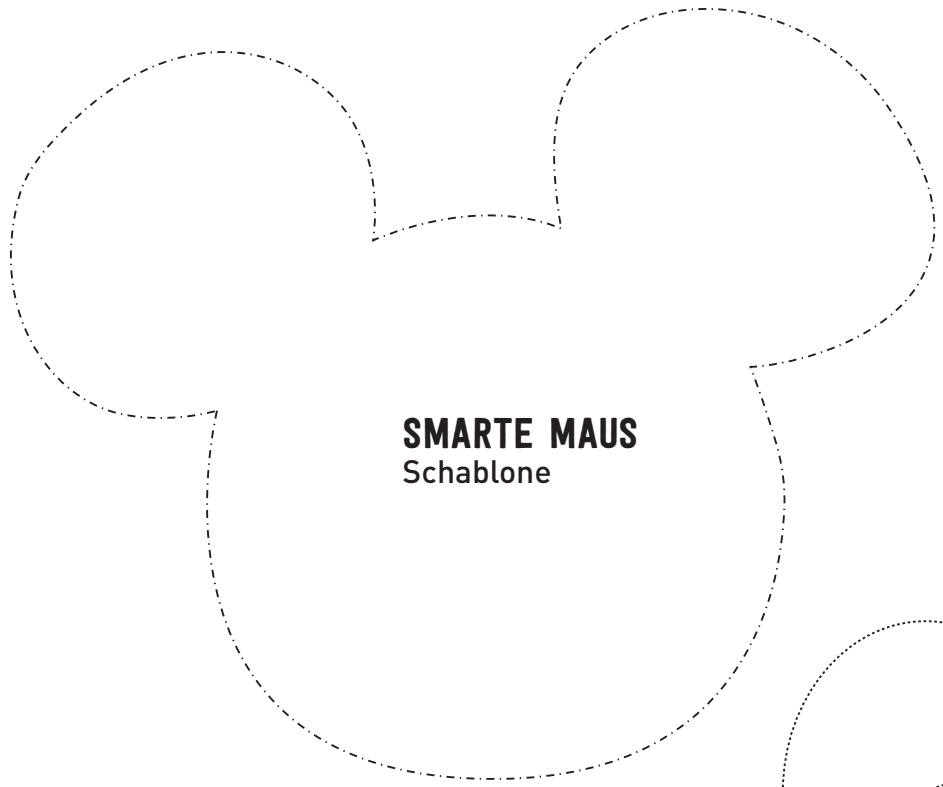

SMARTE MAUS
Schablone

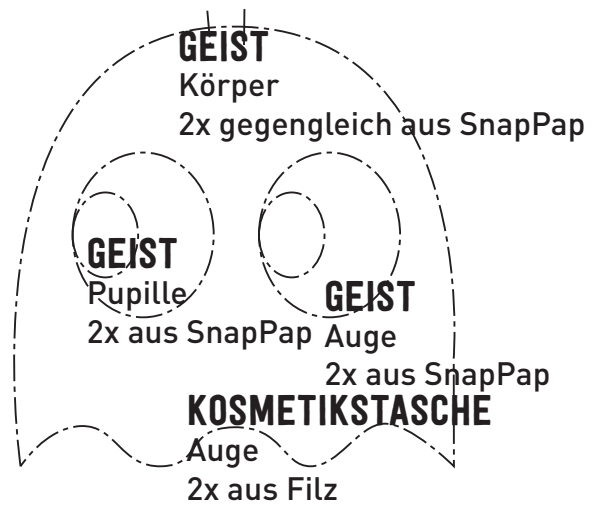

GEIST
Körper
2x gegengleich aus SnapPap

GEIST
Pupille
2x aus SnapPap

GEIST
Auge
2x aus SnapPap

KOSMETIKSTASCHE
Auge
2x aus Filz

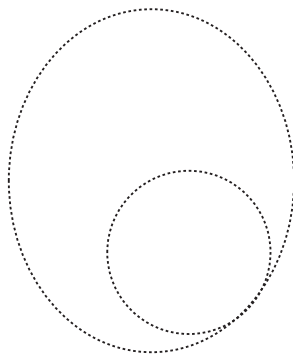

KOSMETIKSTASCHE
Pupille
2x aus Filz



KOSMETIKSTASCHE
Keks
2x aus Filz

5

5

C

D

HANDYHÜLLE
Auge
2x aus Filz



HANDYHÜLLE
Punkte
3x aus Filz

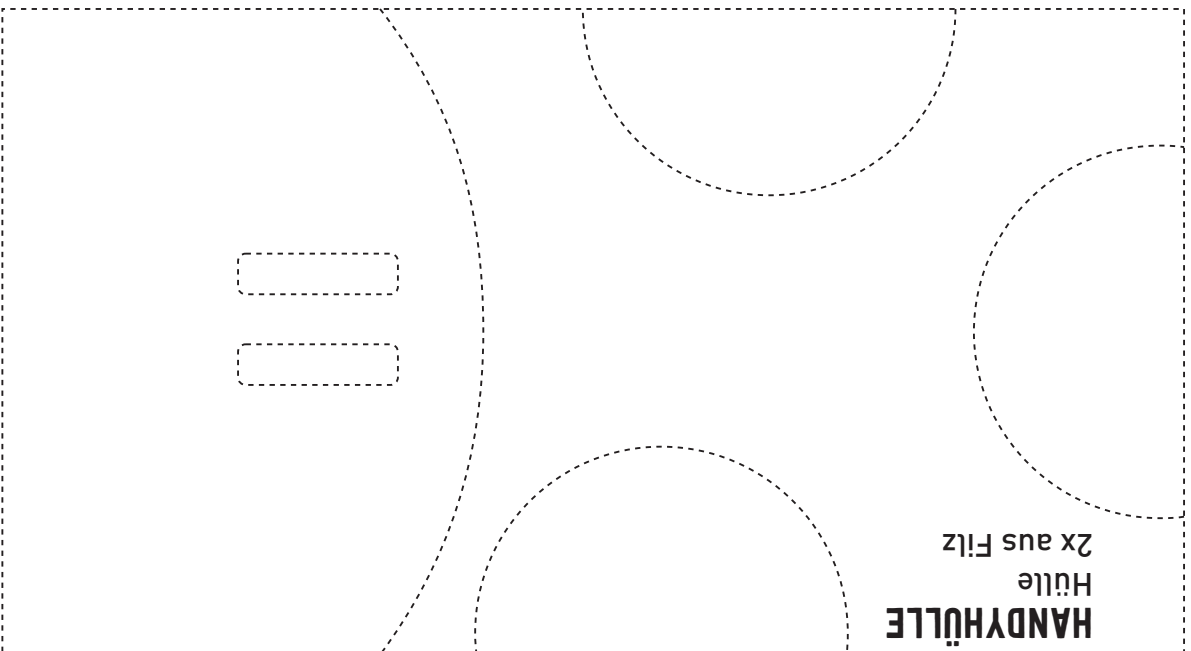

HANDYHÜLLE
Hülle
2x aus Filz

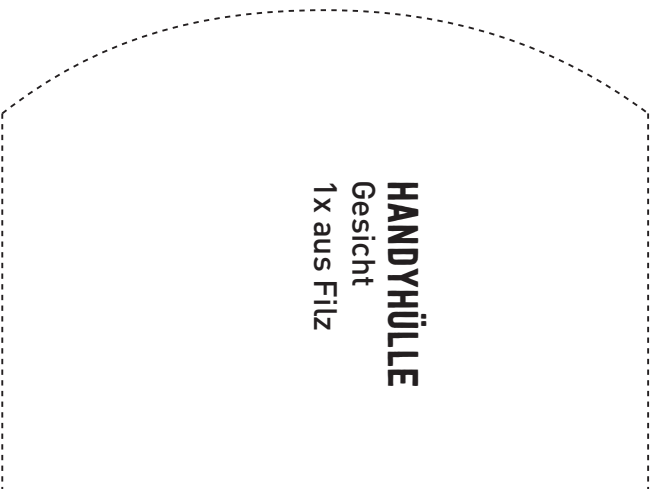

HANDYHÜLLE
Gesicht
1x aus Filz

3

3

6

6

D

D

4
4

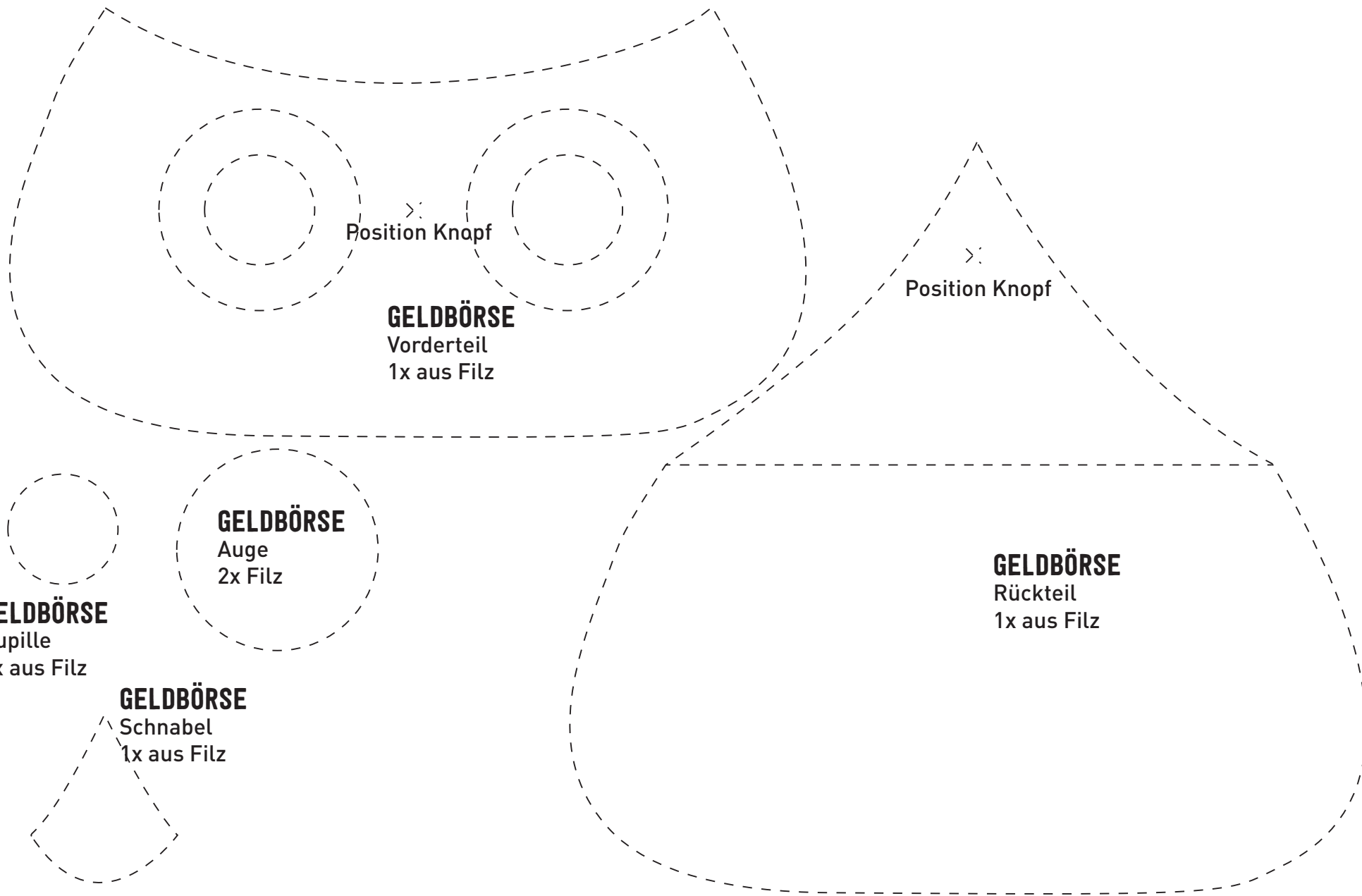

>:
Position Knopf

>:
Position Knopf

GELDBÖRSE
Vorderteil
1x aus Filz

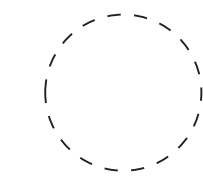

GELDBÖRSE
Pupille
2x aus Filz



GELDBÖRSE
Auge
2x Filz

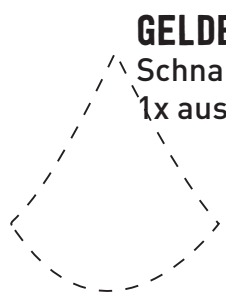

GELDBÖRSE
Schnabel
1x aus Filz

GELDBÖRSE
Rückteil
1x aus Filz

E

7
7

KOSMETIKSTASCHE

Tasche

2x aus Kunstfell gegengleich

2x aus Futterstoff gegengleich

Wendeöffnung Futter

5

5

8

8

E E

F F



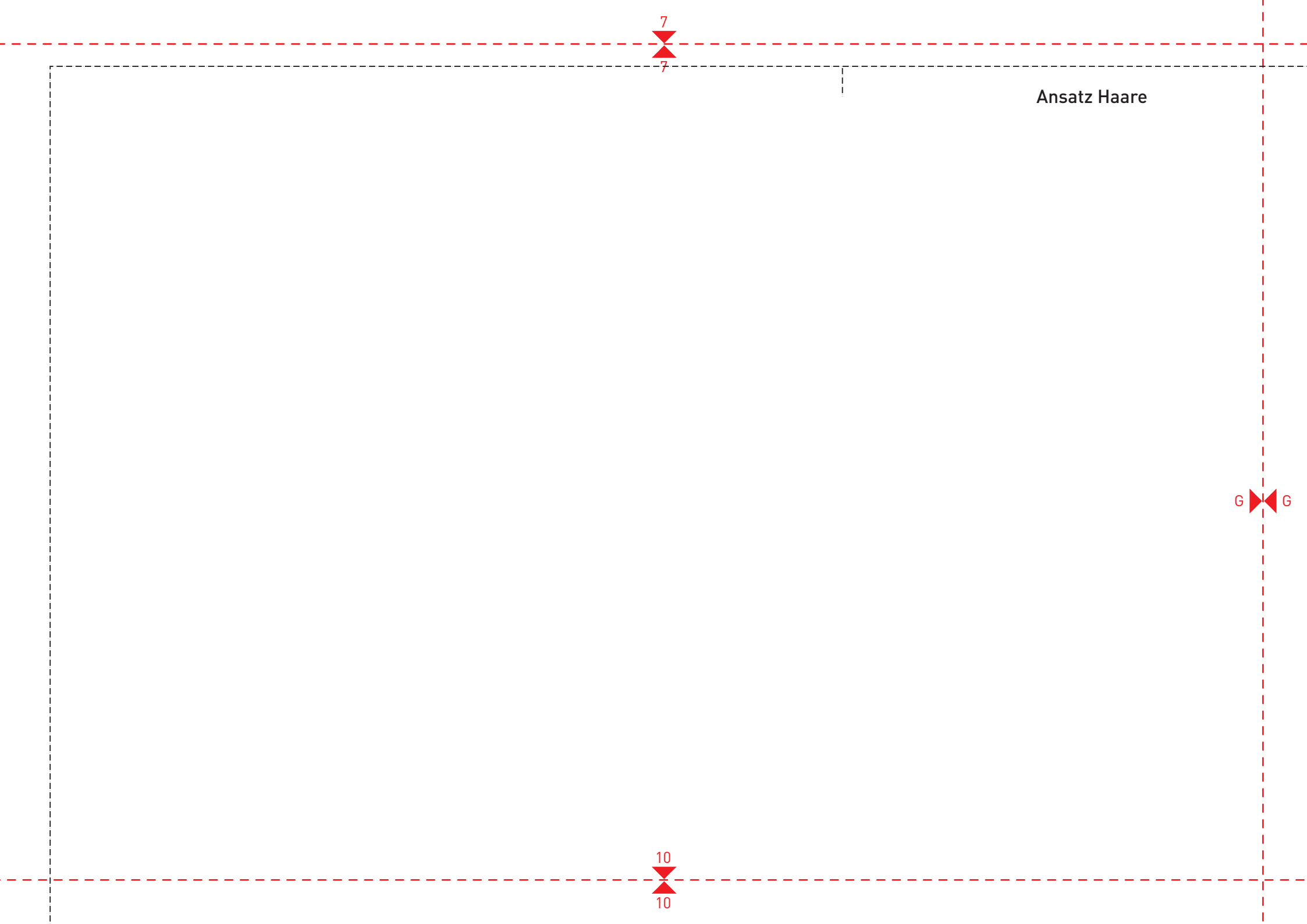

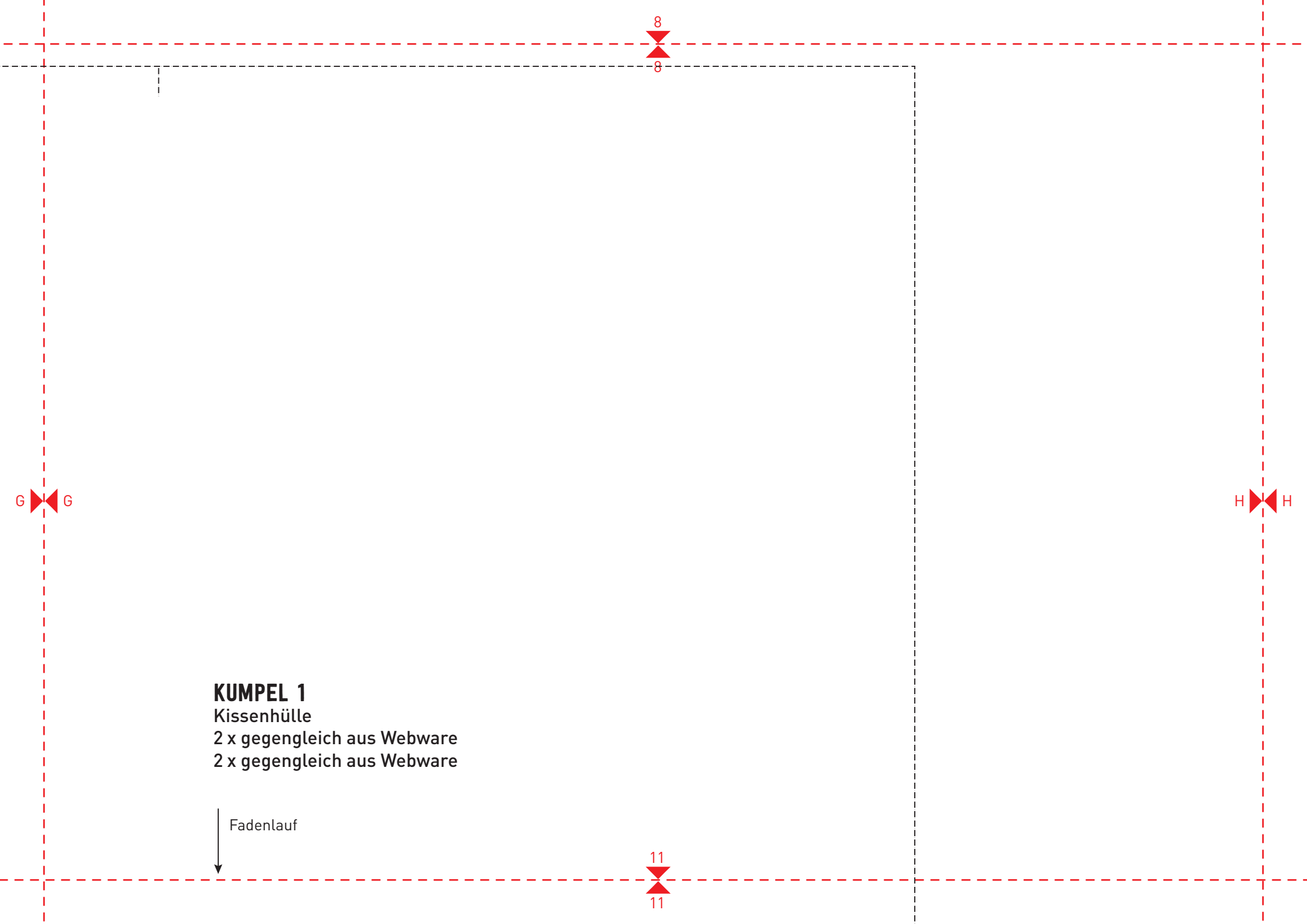

KUMPEL 1

Kissenhülle

2 x gegengleich aus Webware

2 x gegengleich aus Webware

Fadenlauf



8

8

11

11

G

G

H

H

9



9

BEUTEL
Unterteil
2x aus Webware



Fadenlauf

H



H

12



12

10



10

Ansatz Haare



13



13



11
11



SCHLAFMASKE

Maske

2x gegengleich aus Fleece

1x aus Volumenvlies (ohne NZ)

Ansatz Gummiband

Ansatz Ohr

14
14

BEUTEL
Tunnelzug
2x gegengleich aus Webware

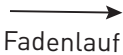

12
12

15
15

BEUTEL
Oberteil

13
▼
▲
13

KUMPEL 2
Kissenhülle
2 x gegengleich aus Webware
2 x gegengleich aus Webware

Fadenlauf
↓

K ▲
▼ K

KUMPEL 2
Augenbraue
1x aus Kunstfell

16
▼
▲
16

ware
ware

14
14

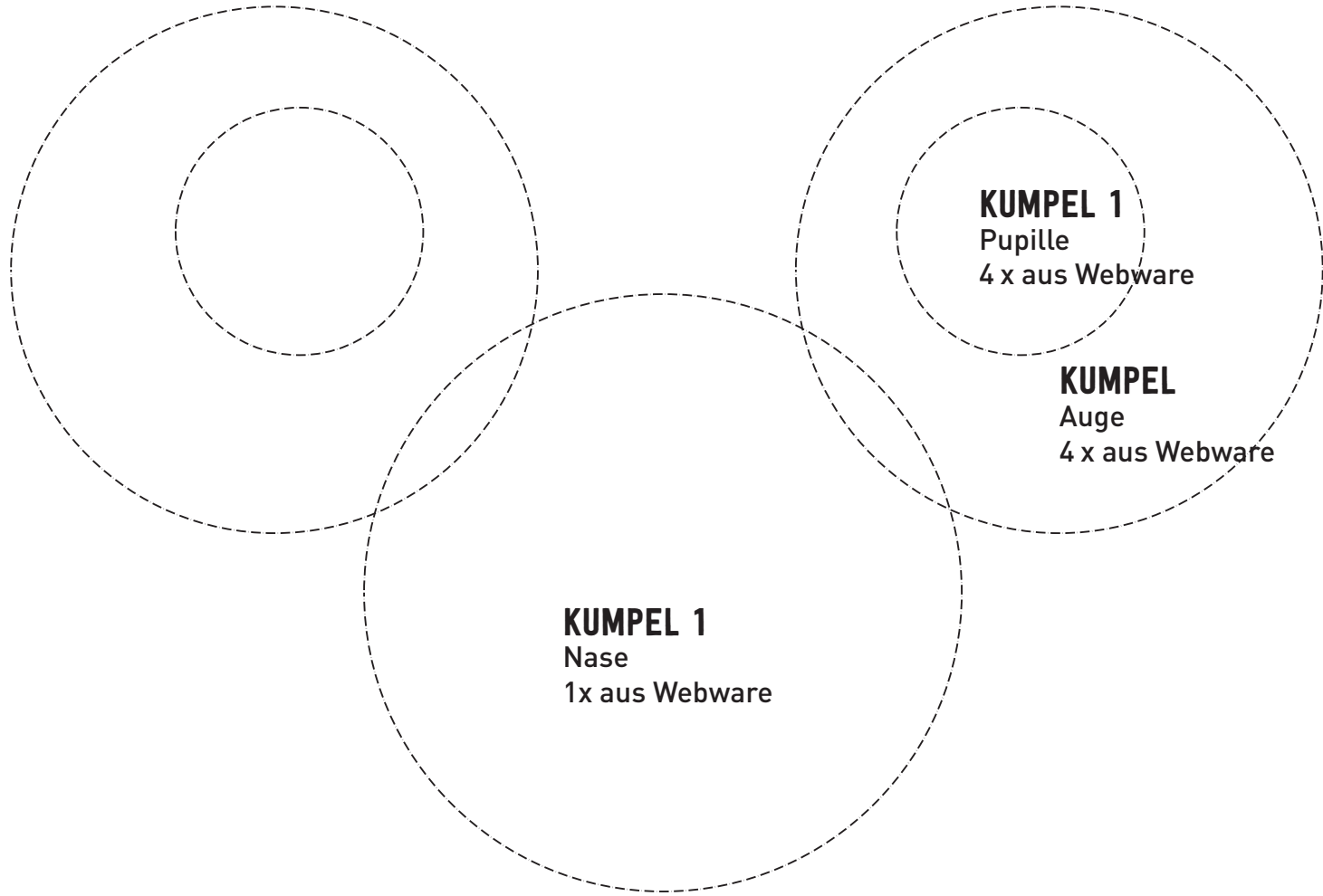

K K

L L

17
17

BEUTEL

Oberteil

2x gegengleich aus Webware



Fadenlauf

15

15

L L

18

18

16

16

KUMPEL 2
Haare

KUMPEL 1
Haare

M M

19

19

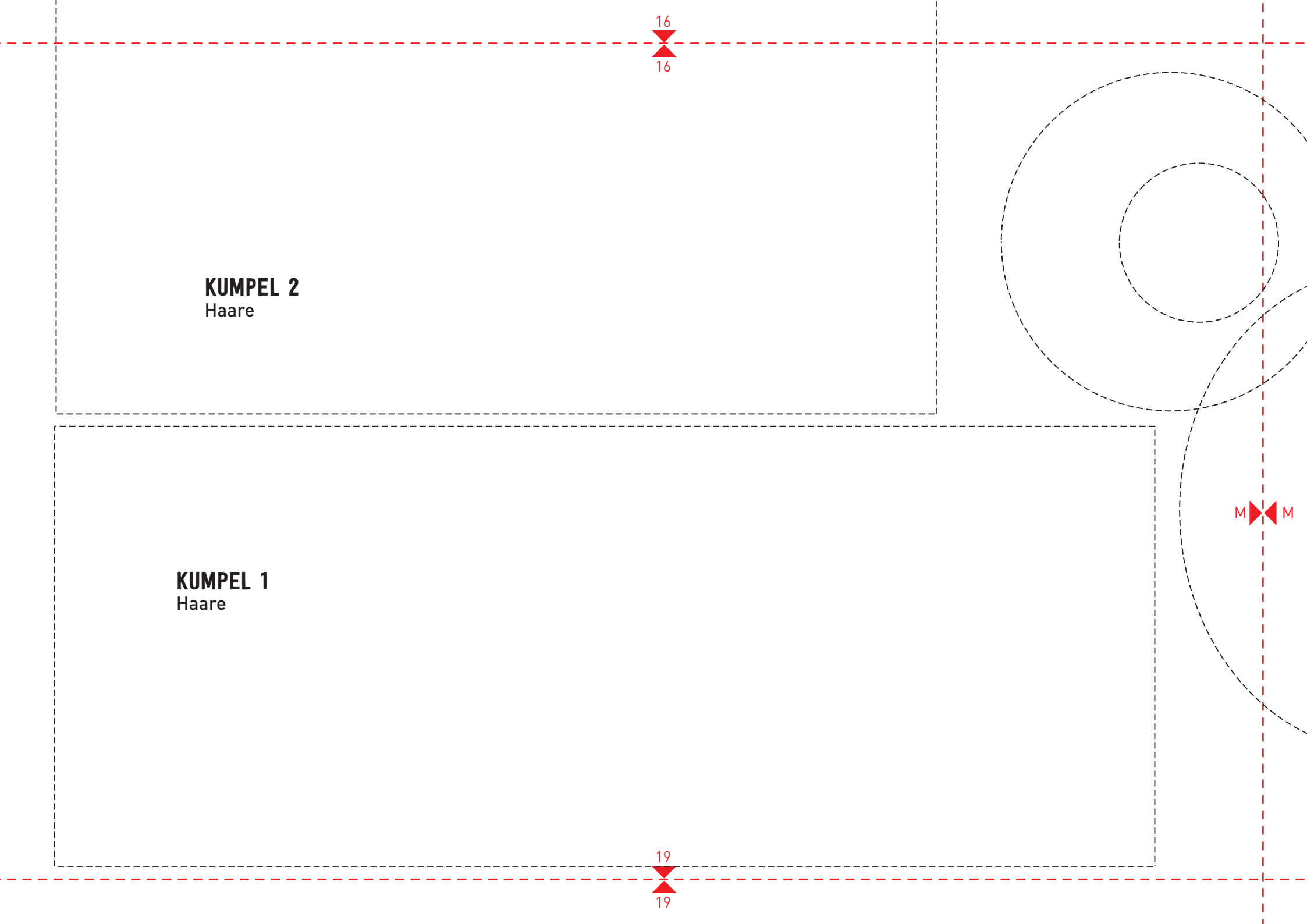

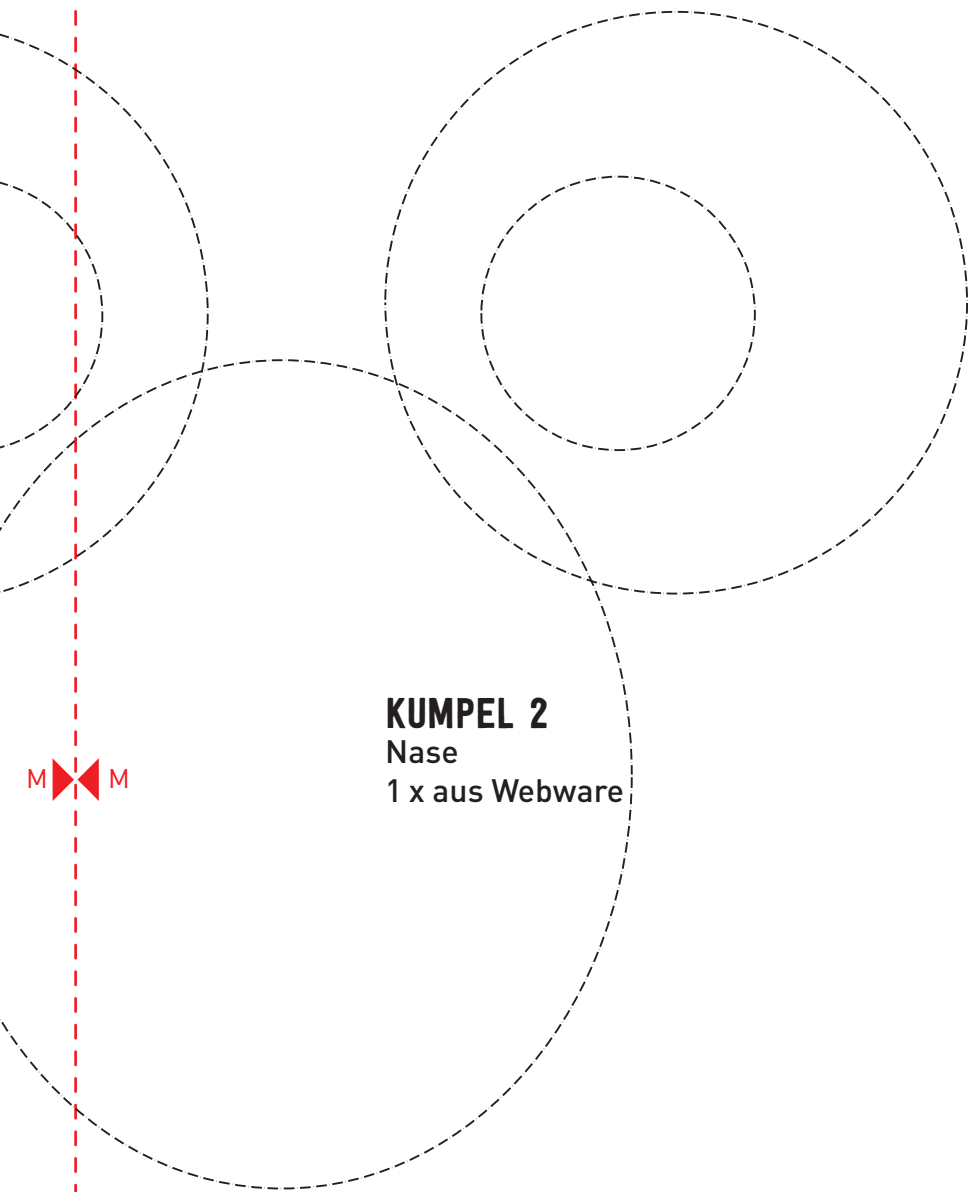

KUMPEL 2
Nase
1 x aus Webware

M M

17
17

20
20

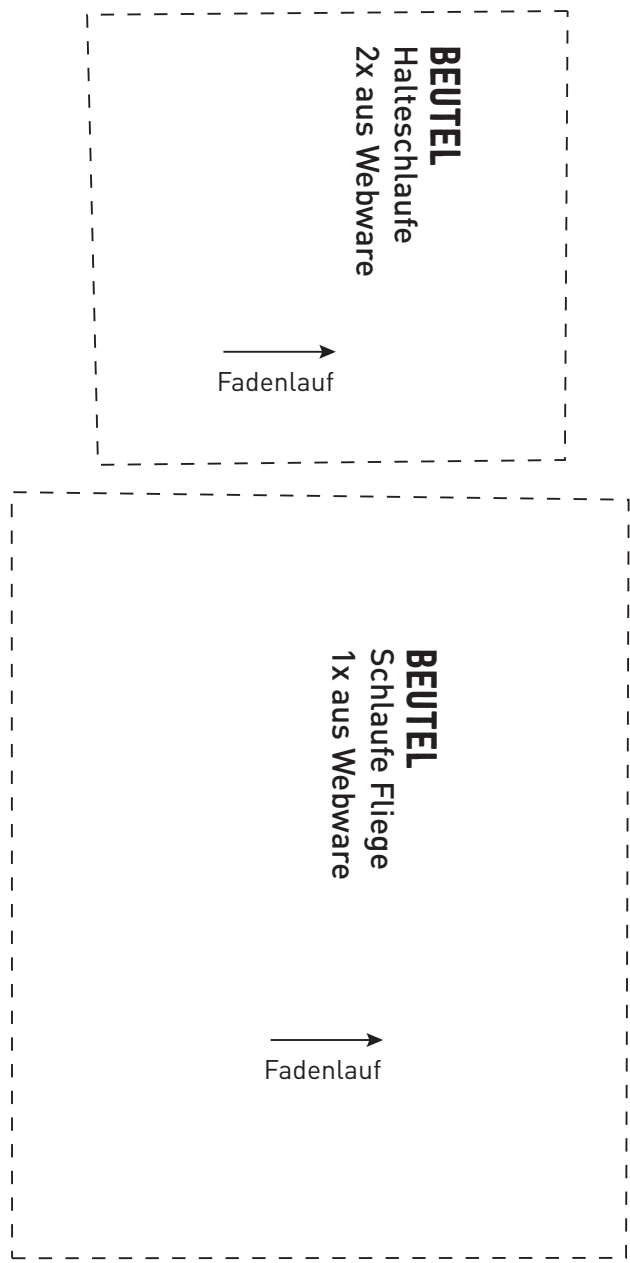

BEUTEL
Halteschlaufe
2x aus Webware

→
Fadenlauf

BEUTEL
Schlaufe Fliege
1x aus Webware

→
Fadenlauf

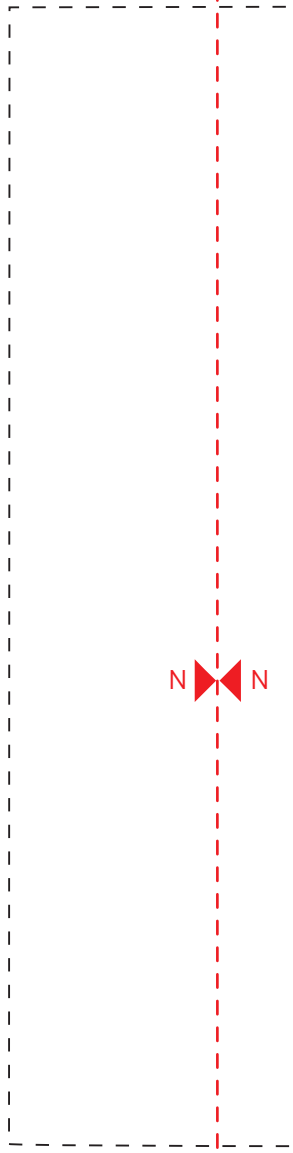

N N

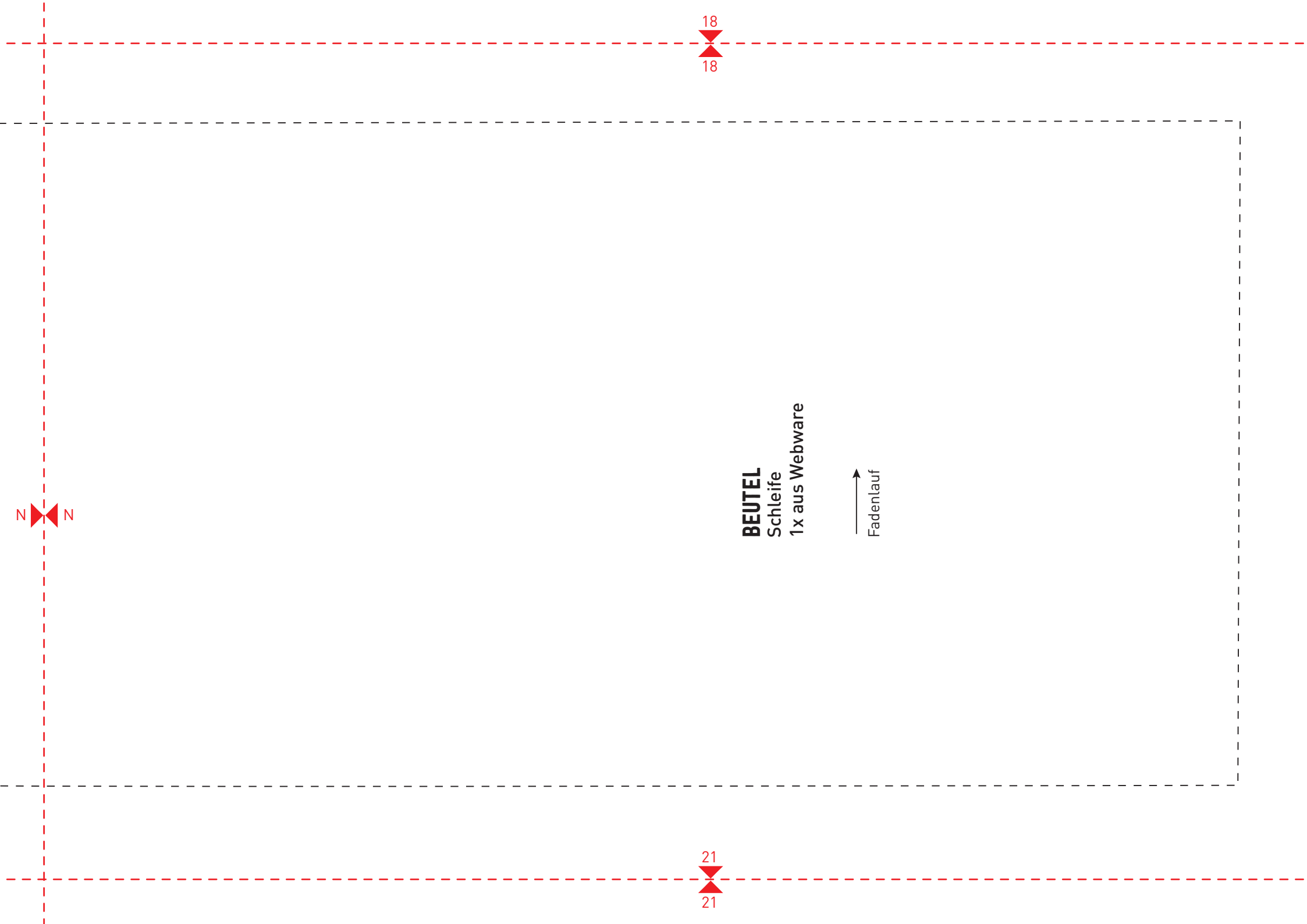

18

18

N

N

BEUTEL
Schleife
1x aus Webware

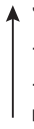

Fadenlauf

21

21

19

19

Fadenlauf



EINKAUFSTASCHE
Henkel
2x gegengleich aus Webware

P

P

22

22



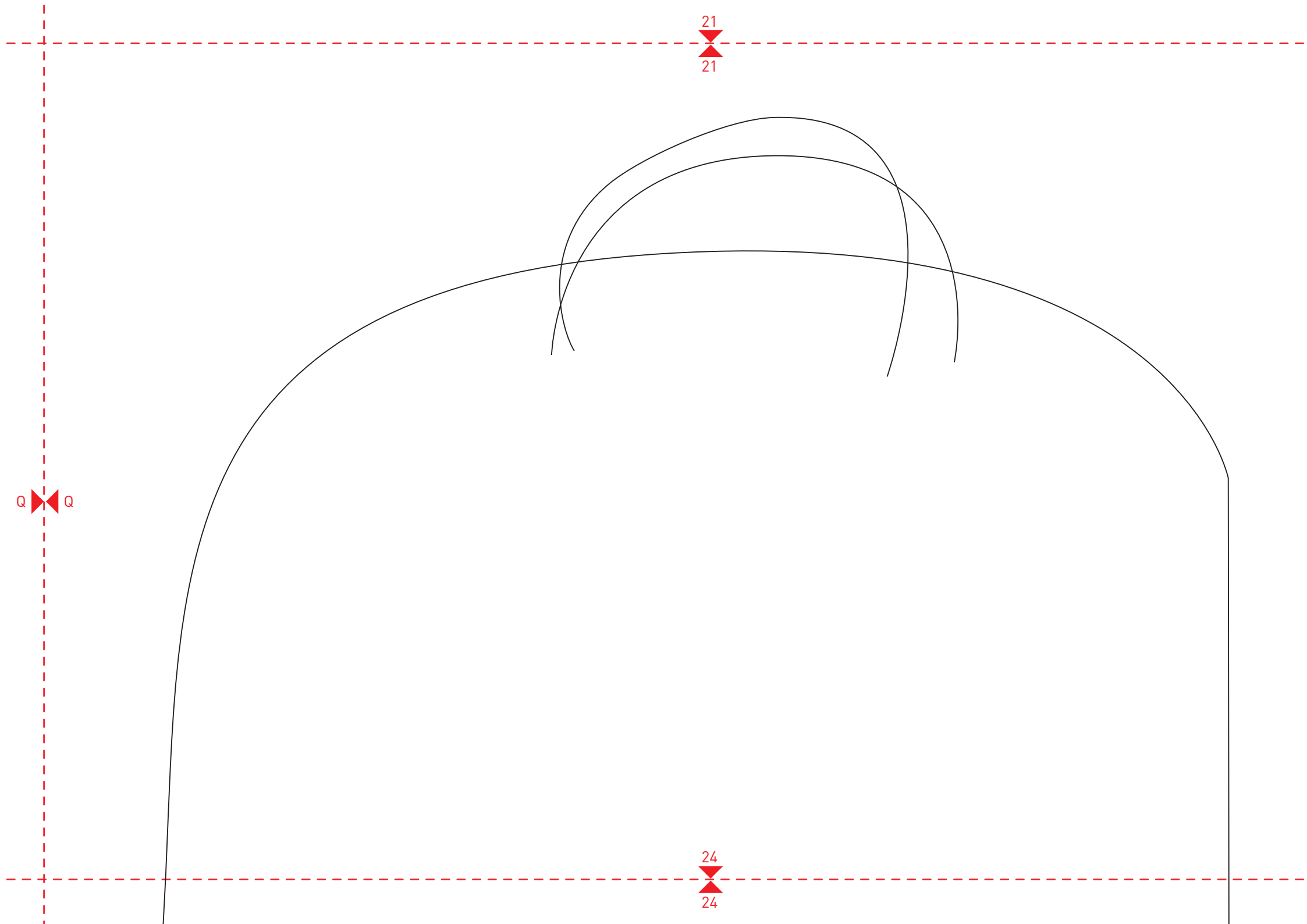

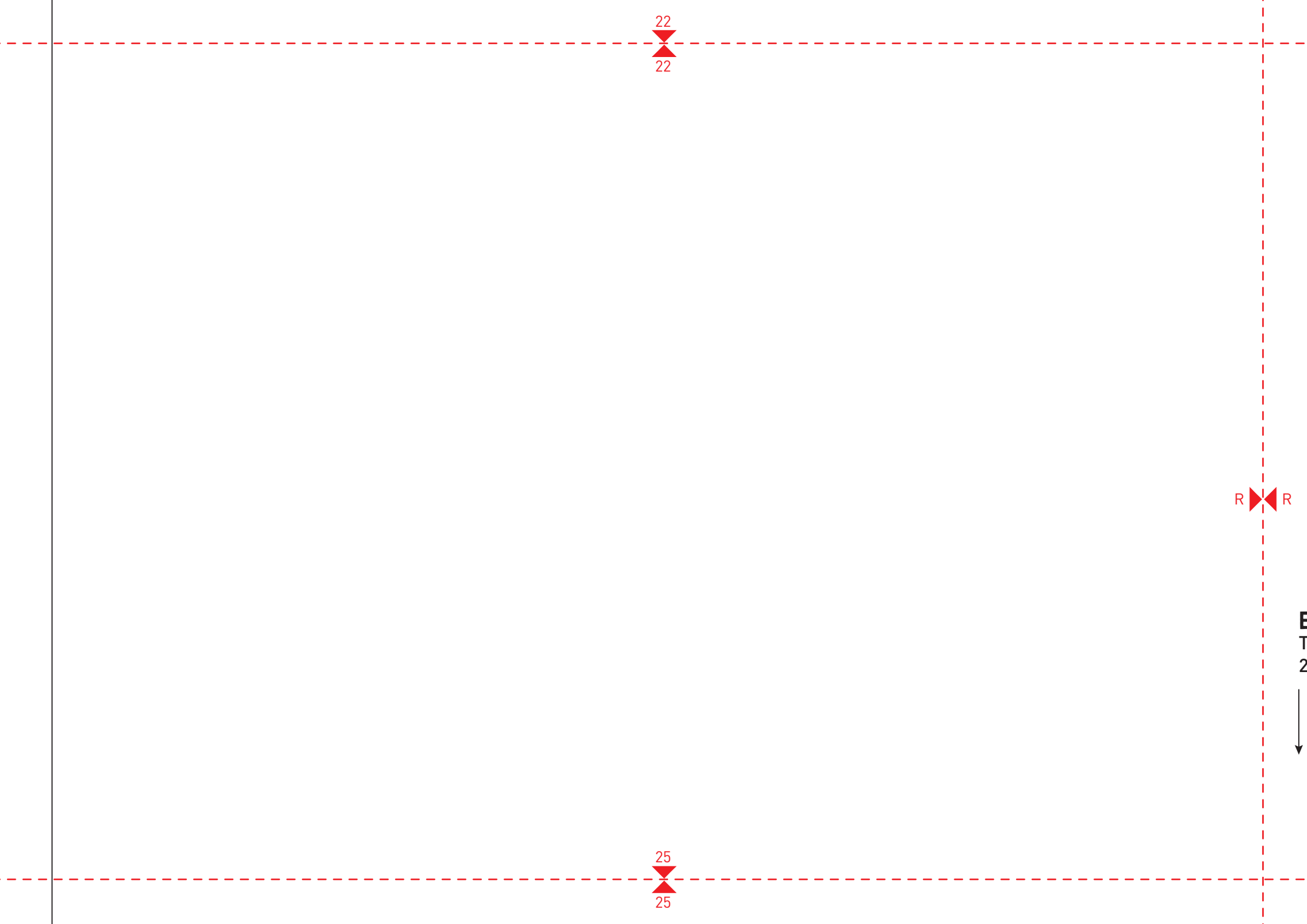

23

23

R R

S S

EINKAUFSTASCHE

Tasche

2x gegengleich aus Webware

Fadenlauf

26

26

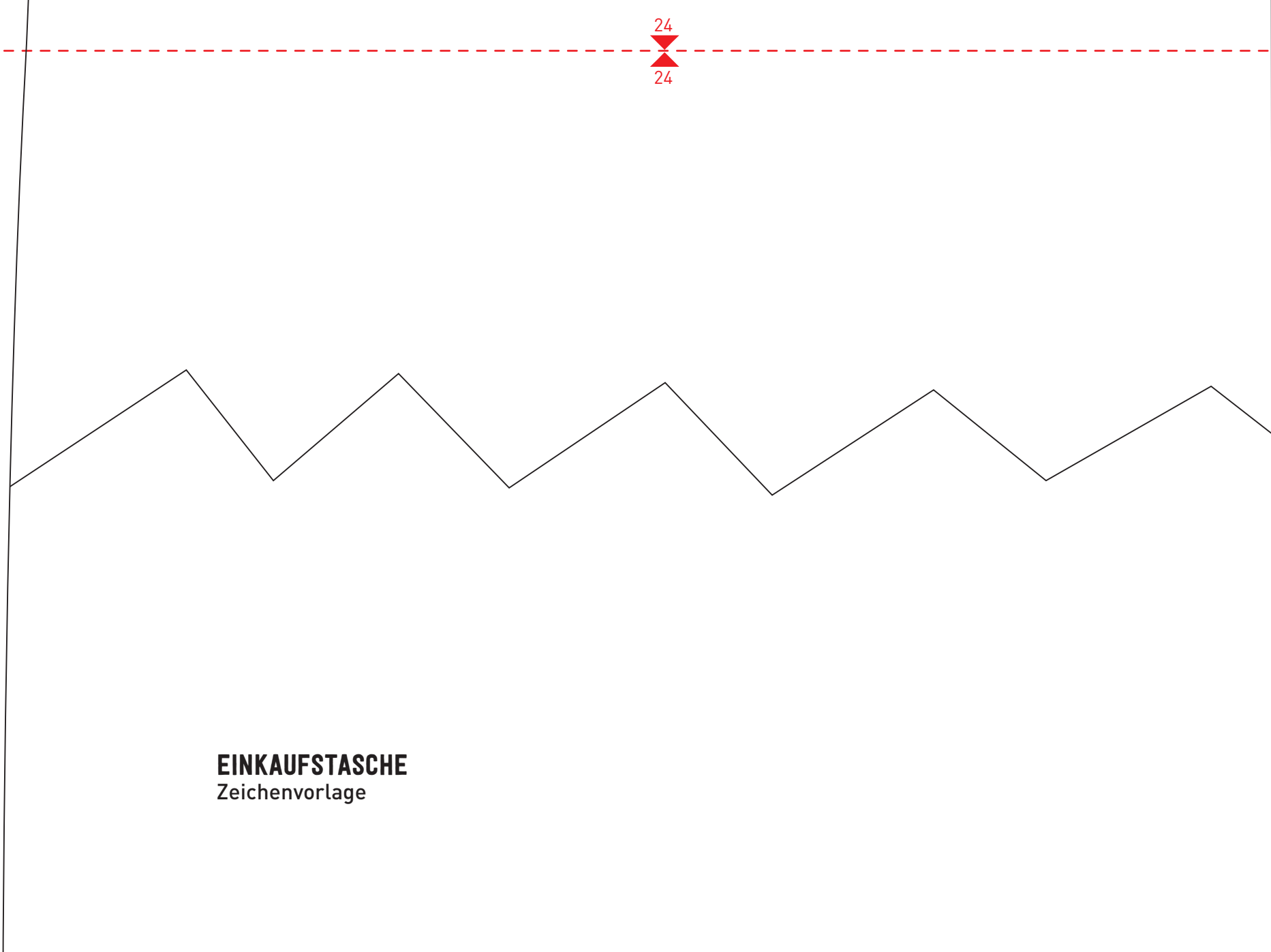

EINKAUFSTASCHE
Zeichenvorlage

S S

24
24

27
27

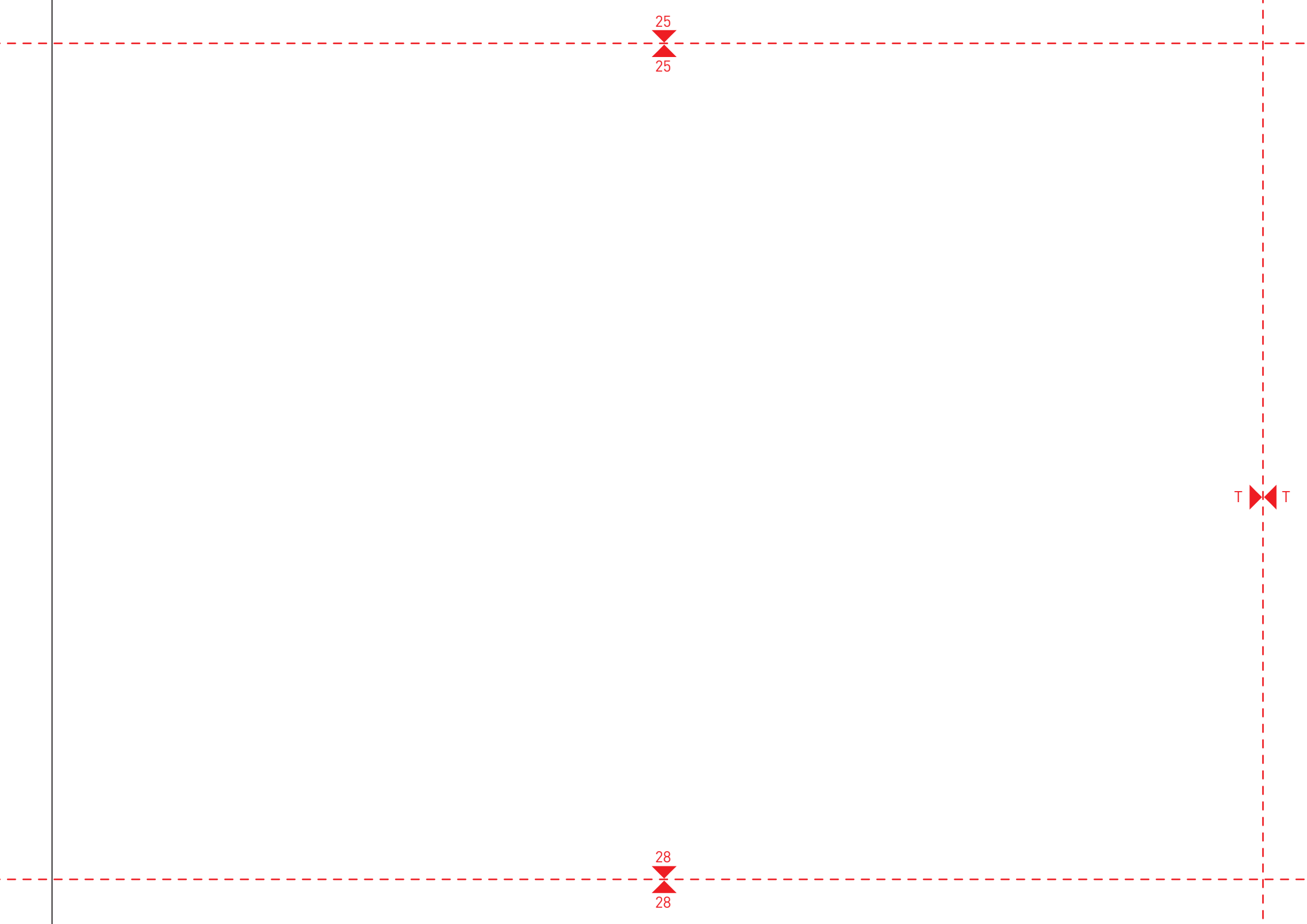

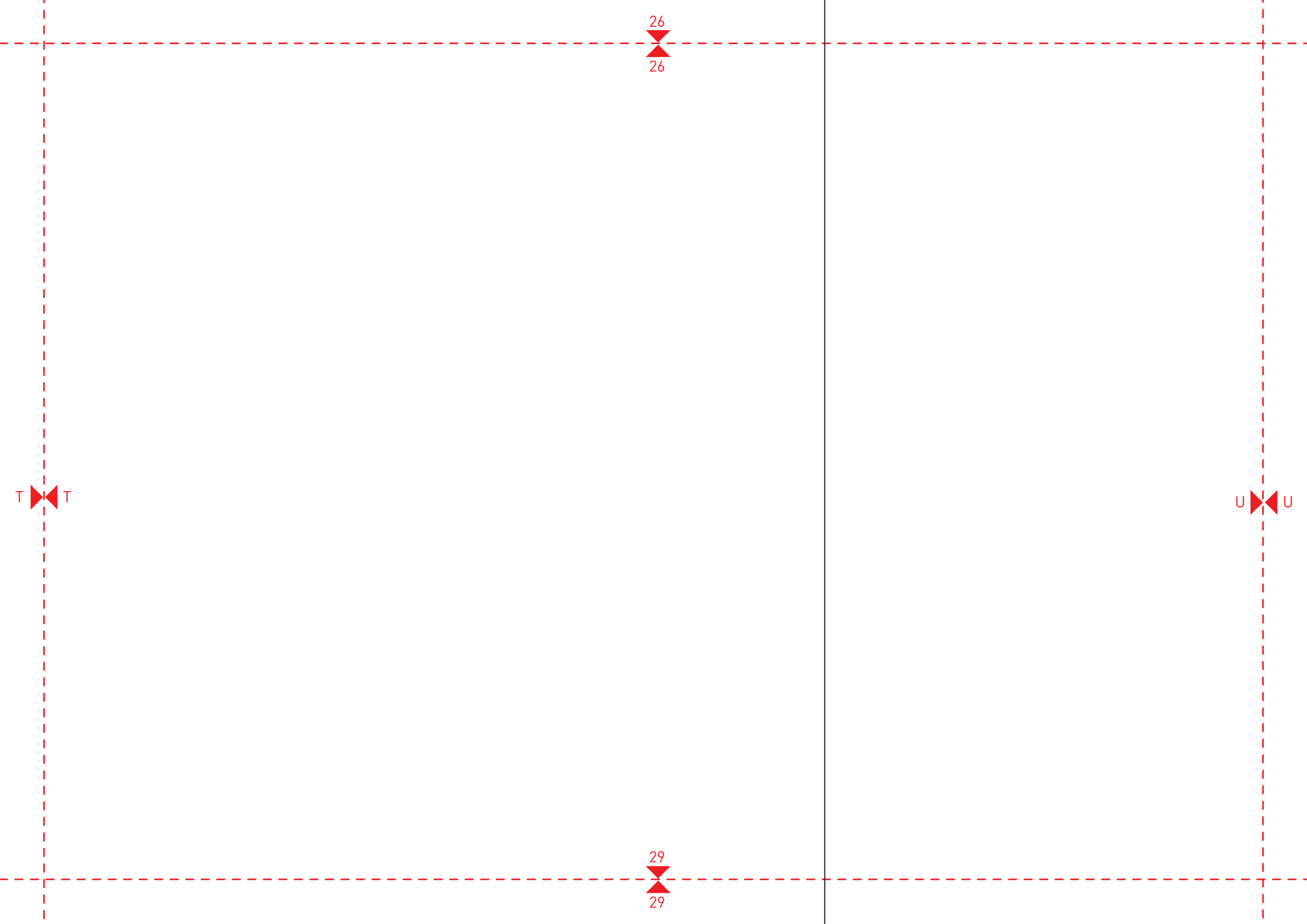

27
27

EINKAUFSTASCHE
Schablone Haare

U U

30
30

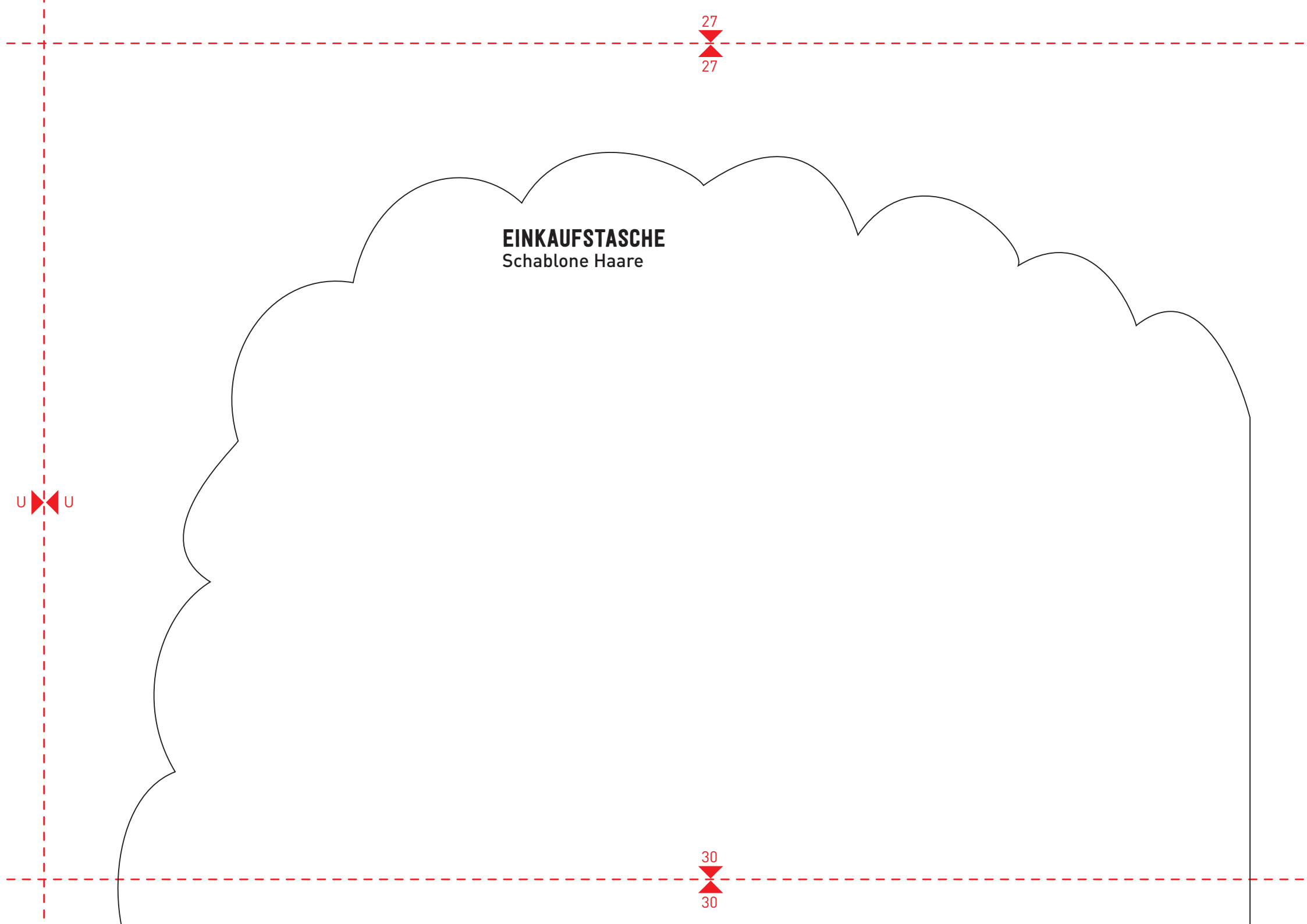

Position Gummiband

BRILLENETUI

Etui

2x gegengleich aus Popeline Gelb

2x gegengleich aus Popeline Blau

2x Style-Vil



Position Knopf

28

28

V V

V

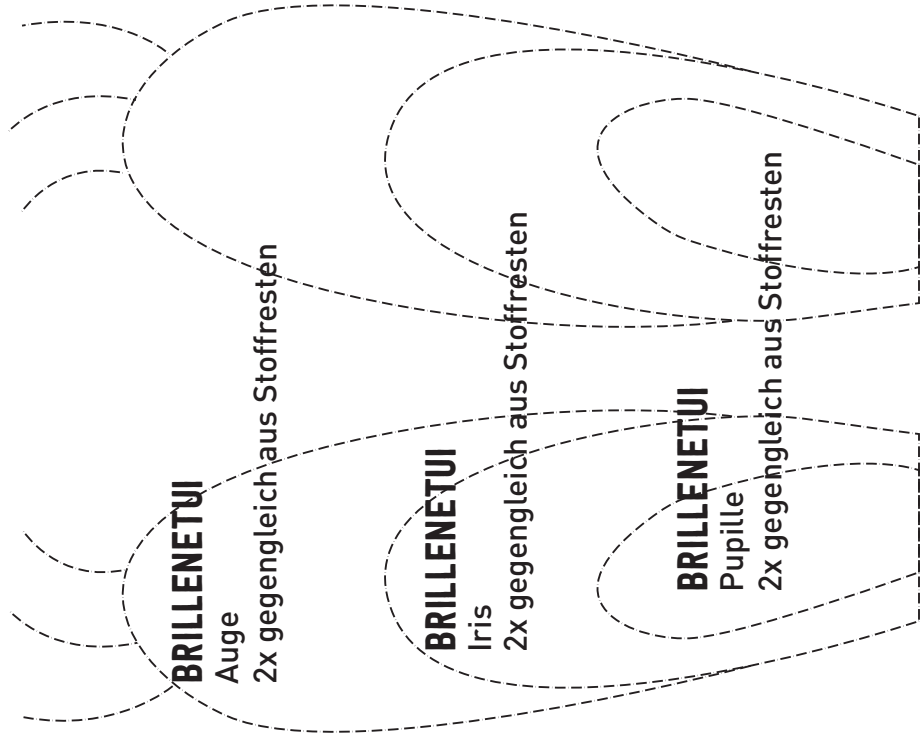

29

W

